



FRAZIER & SON

PO Box 2847
Conroe, Texas 77305

101 Longview Drive
Conroe, Texas 77301

800.365.5438
936.494.4040
Fax: 936.494.4045

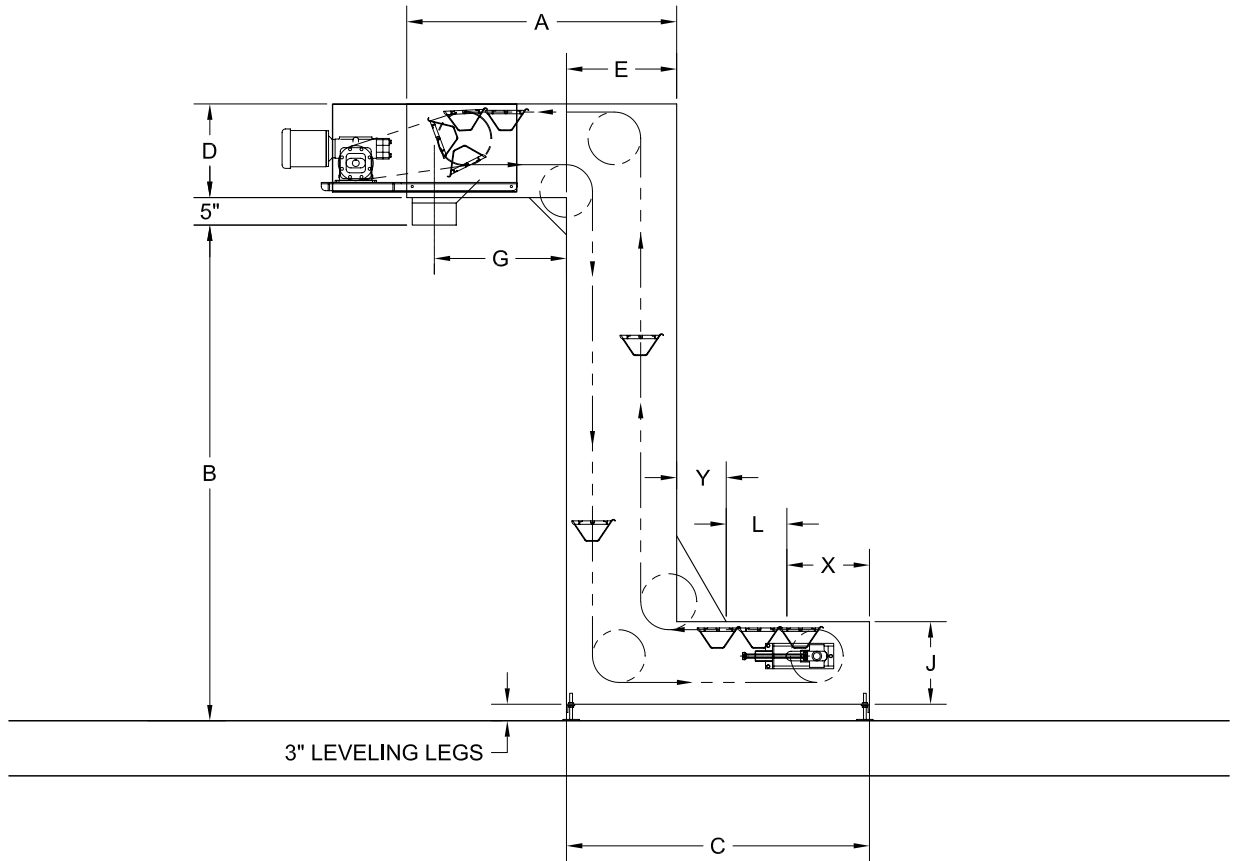
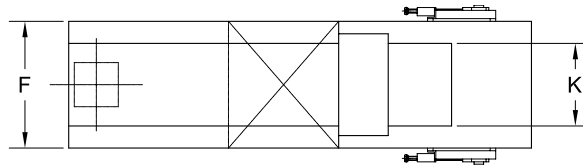

BUCKET ELEVATORS CONFIGURATION SHEET 1

WHIZ-LIFTER MODEL C SANITARY CHANNEL FRAME CONSTRUCTION

BUCKET SIZE	A*	C*	D	E	F	G*	J	K	L	X	Y
4" x 8"	35	36	12	13	15	18	10	8	7	10	6
6" x 10"	42	42	14	17	17	21	12	10	6	12	7
7-1/2" x 15"	49	55	17	20	23	24	15	15	11	15	9
9" x 20"	60	72	20	23	28	30	18	20	19	19	11
12" x 30"	73	90	26	30	39	36	24	30	21	24	15

*Minimum Dimensions



FRAZIER & SON

PO Box 2847
Conroe, Texas 77305

101 Longview Drive
Conroe, Texas 77301

800.365.5438
936.494.4040
Fax: 936.494.4045

BUCKET ELEVATORS
CONFIGURATION SHEET 2

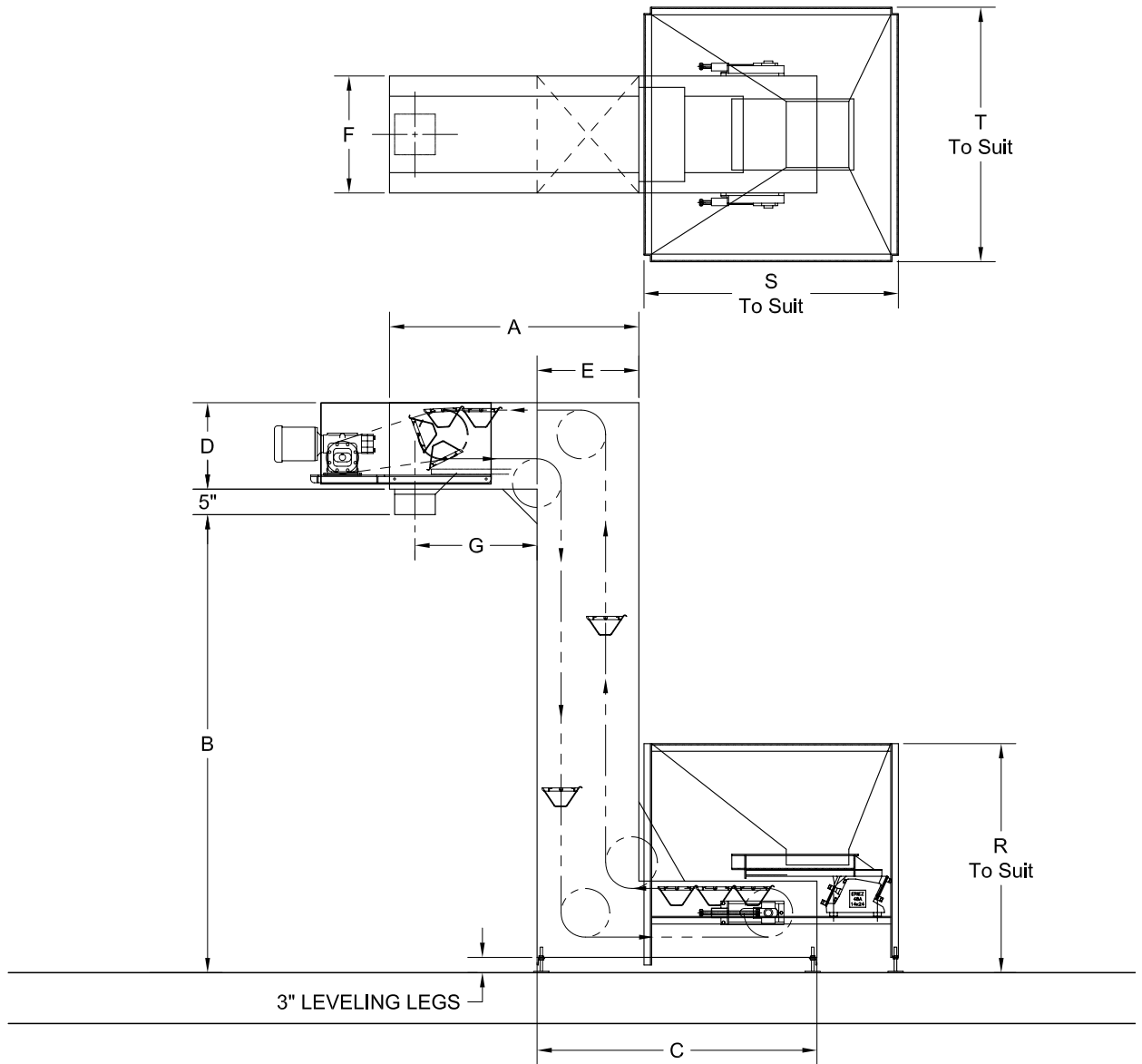

WHIZ-LIFTER
MODEL C with HOPPER and VIBRATORY FEEDER
SANITARY CHANNEL FRAME CONSTRUCTION

BUCKET SIZE	A*	C*	D	E	F	G*	J	R	S	T
4" x 8"	35	36	12	13	15	18	10	35	45	35
6" x 10"	42	42	14	17	17	21	12	35	45	35
7-1/2" x 15"	49	55	17	20	23	24	15	45	50	50
9" x 20"	60	72	20	23	28	30	18	●	●	●
12" x 30"	73	90	26	30	39	36	24	●	●	●

*Minimum Dimensions

●Denotes Custom Dimensions



FRAZIER & SON

PO Box 2847
Conroe, Texas 77305

101 Longview Drive
Conroe, Texas 77301

800.365.5438
936.494.4040
Fax: 936.494.4045

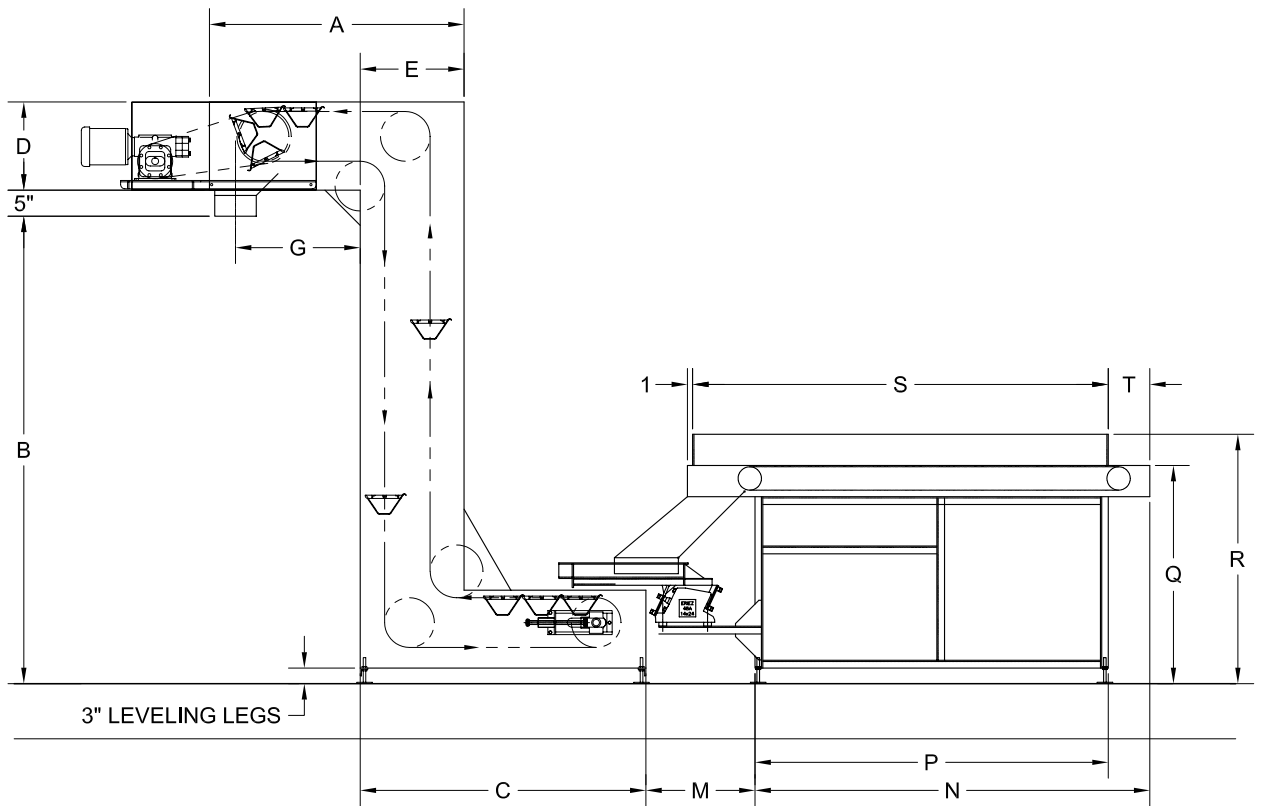
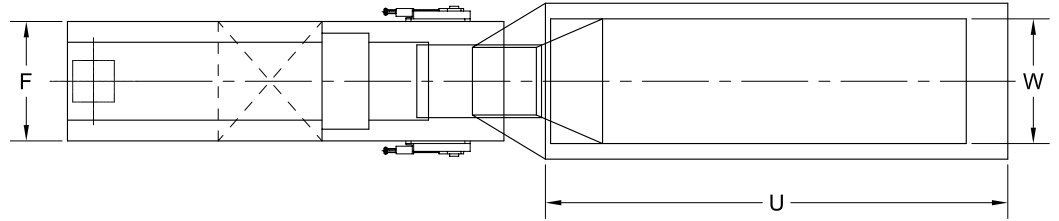

BUCKET ELEVATORS
CONFIGURATION SHEET 3

WHIZ-LIFTER
MODEL C with STORAGE BELT and VIBRATORY FEEDER
SANITARY CHANNEL FRAME CONSTRUCTION

BUCKET SIZE	A*	C*	D	E	F	G*	J	M	N	P	Q	R	S	T
4" x 8"	35	36	12	13	15	18	10	18	72	66	35	41	78	6
6" x 10"	42	42	14	17	17	21	12	18	72	66	35	41	78	6
7-1/2" x 15"	49	55	17	20	23	24	15	20	74	66	42	51	80	9
9" x 20"	60	72	20	23	28	30	18	19	80	72	42	51	84	9
12" x 30"	73	90	26	30	39	36	24	22	86	78	44	56	90	12

*Minimum Dimensions



FRAZIER & SON

PO Box 2847
Conroe, Texas 77305

101 Longview Drive
Conroe, Texas 77301

800.365.5438
936.494.4040
Fax: 936.494.4045

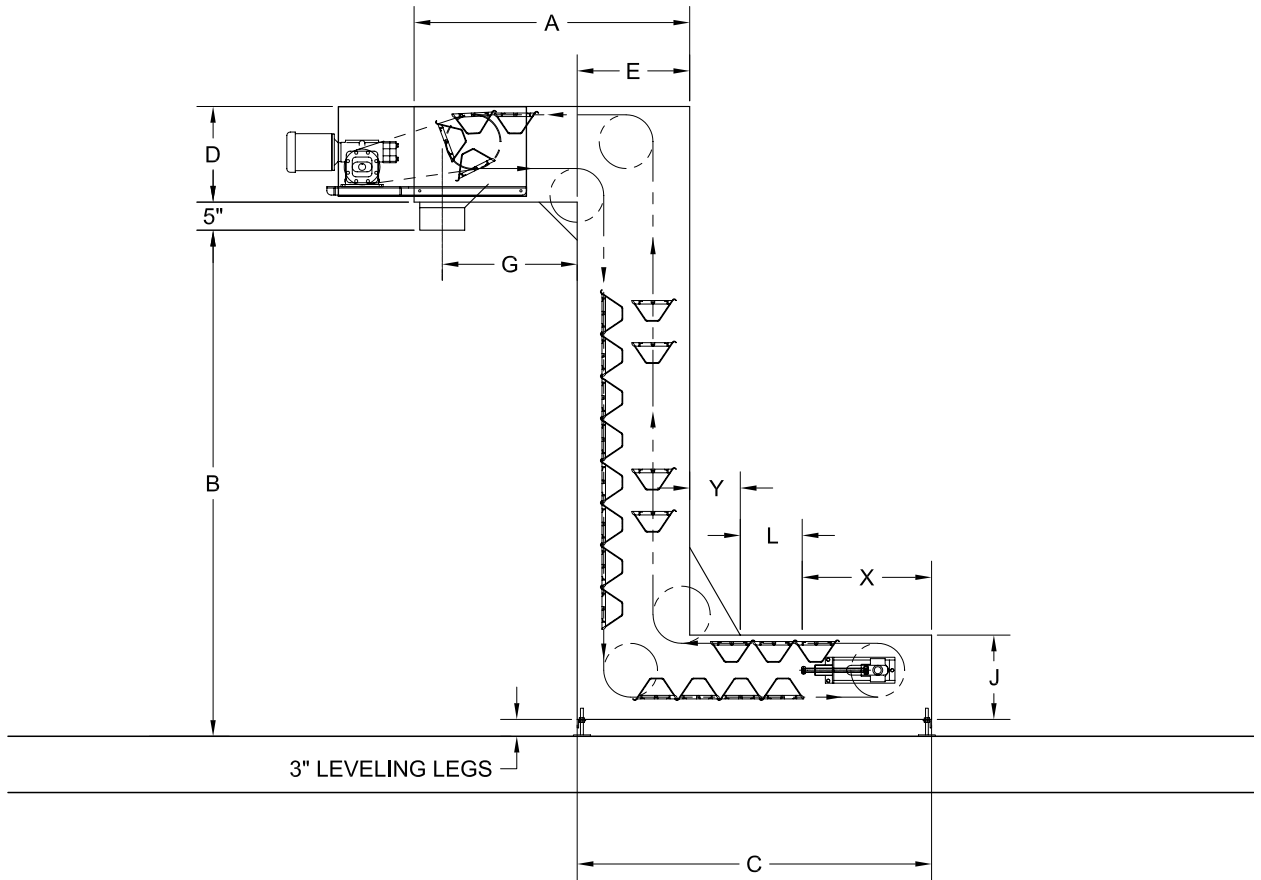
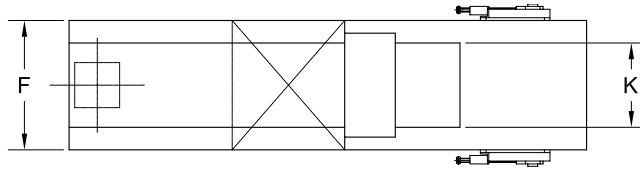

BUCKET ELEVATORS CONFIGURATION SHEET 4

WHIZ-LIFTER **MODEL C WASHDOWN** **SANITARY CHANNEL FRAME CONSTRUCTION**

BUCKET SIZE	A*	C*	D	E	F	G*	J	K	L	X*	Y
4" x 8"	35	40	12	13	15	18	10	8	7	14	6
6" x 10"	42	48	14	17	17	21	12	10	6	18	7
7-1/2" x 15"	49	63	17	20	23	24	15	15	11	23	9
9" x 20"	60	81	20	23	28	30	18	20	19	28	11
12" x 30"	73	102	26	30	39	36	24	30	21	36	15

*Minimum Dimensions



FRAZIER & SON

PO Box 2847
Conroe, Texas 77305

101 Longview Drive
Conroe, Texas 77301

800.365.5438

936.494.4040

Fax: 936.494.4045

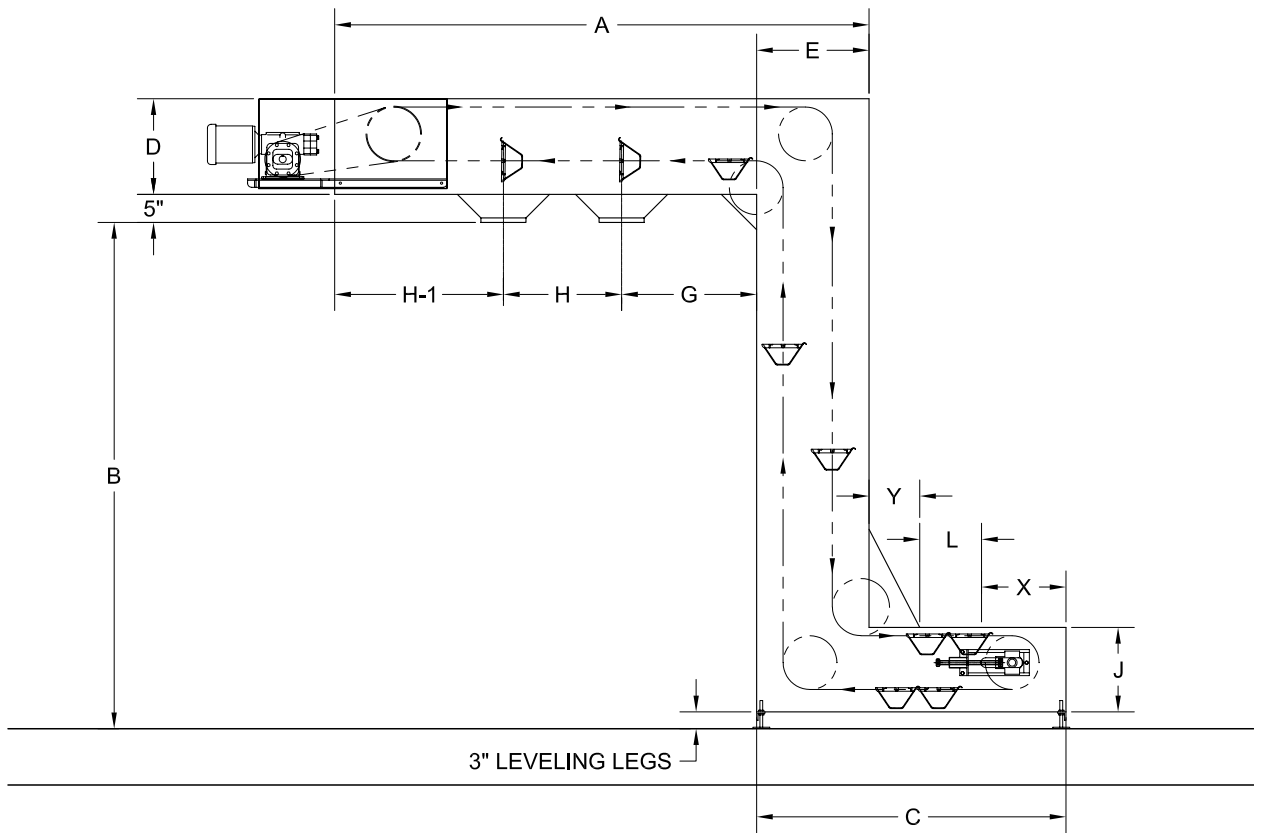
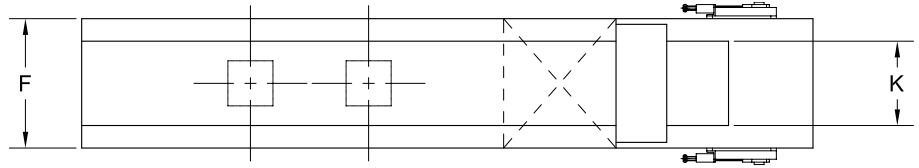

BUCKET ELEVATORS CONFIGURATION SHEET 5

WHIZ-LIFTER MODEL CBT - MULTIPLE DISCHARGE SANITARY CHANNEL FRAME CONSTRUCTION

BUCKET SIZE	A*	C*	D	E	F	G*	H*	H-1	J	K	L	X	Y
4" x 8"	67	48	12	13	15	18	15	21	10	8	19	10	6
6" x 10"	80	52	14	17	17	21	18	24	12	10	16	12	7
7-1/2" x 15"	95	55	17	20	23	24	21	30	15	15	11	15	9
9" x 20"	113	72	20	23	28	30	24	36	18	20	19	19	11
12" x 30"	152	90	26	30	39	36	36	50	24	30	21	24	15

*Minimum Dimensions



FRAZIER & SON

PO Box 2847
Conroe, Texas 77305

101 Longview Drive
Conroe, Texas 77301

800.365.5438

936.494.4040

Fax: 936.494.4045

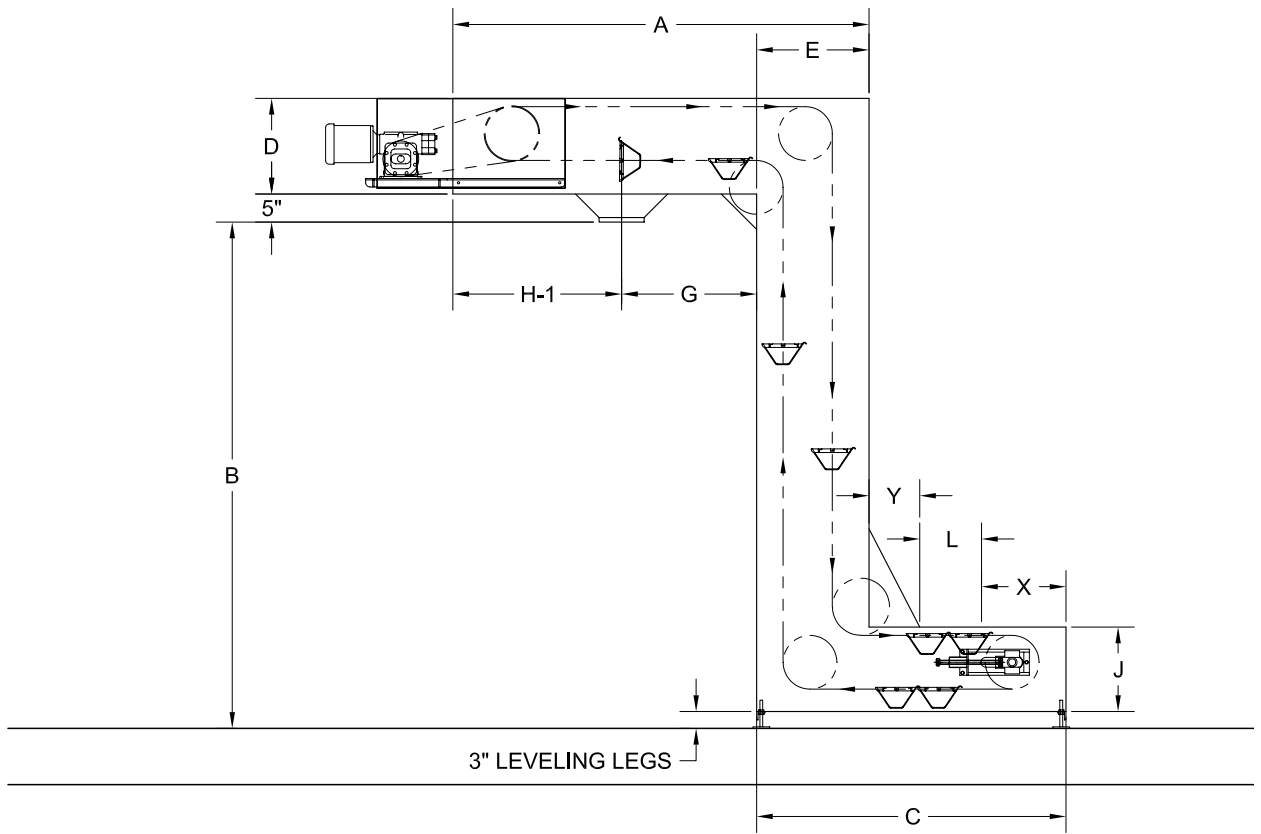
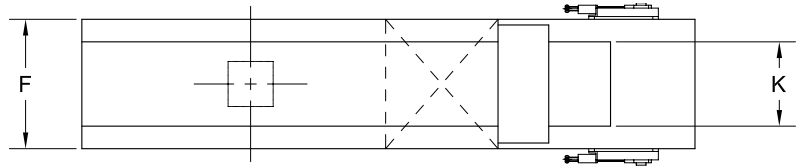

BUCKET ELEVATORS
CONFIGURATION SHEET 5A

WHIZ-LIFTER
MODEL CBT - SINGLE DISCHARGE
SANITARY CHANNEL FRAME CONSTRUCTION

BUCKET SIZE	A*	C*	D	E	F	G*	H-1	J	K	L	X	Y
4" x 8"	67	48	12	13	15	18	21	10	8	19	10	6
6" x 10"	80	52	14	17	17	21	24	12	10	16	12	7
7-1/2" x 15"	95	55	17	20	23	24	30	15	15	11	15	9
9" x 20"	113	72	20	23	28	30	36	18	20	19	19	11
12" x 30"	152	90	26	30	39	36	50	24	30	21	24	15

*Minimum Dimensions



FRAZIER & SON

PO Box 2847
Conroe, Texas 77305

101 Longview Drive
Conroe, Texas 77301

800.365.5438

936.494.4040

Fax: 936.494.4045

BUCKET ELEVATORS CONFIGURATION SHEET 6

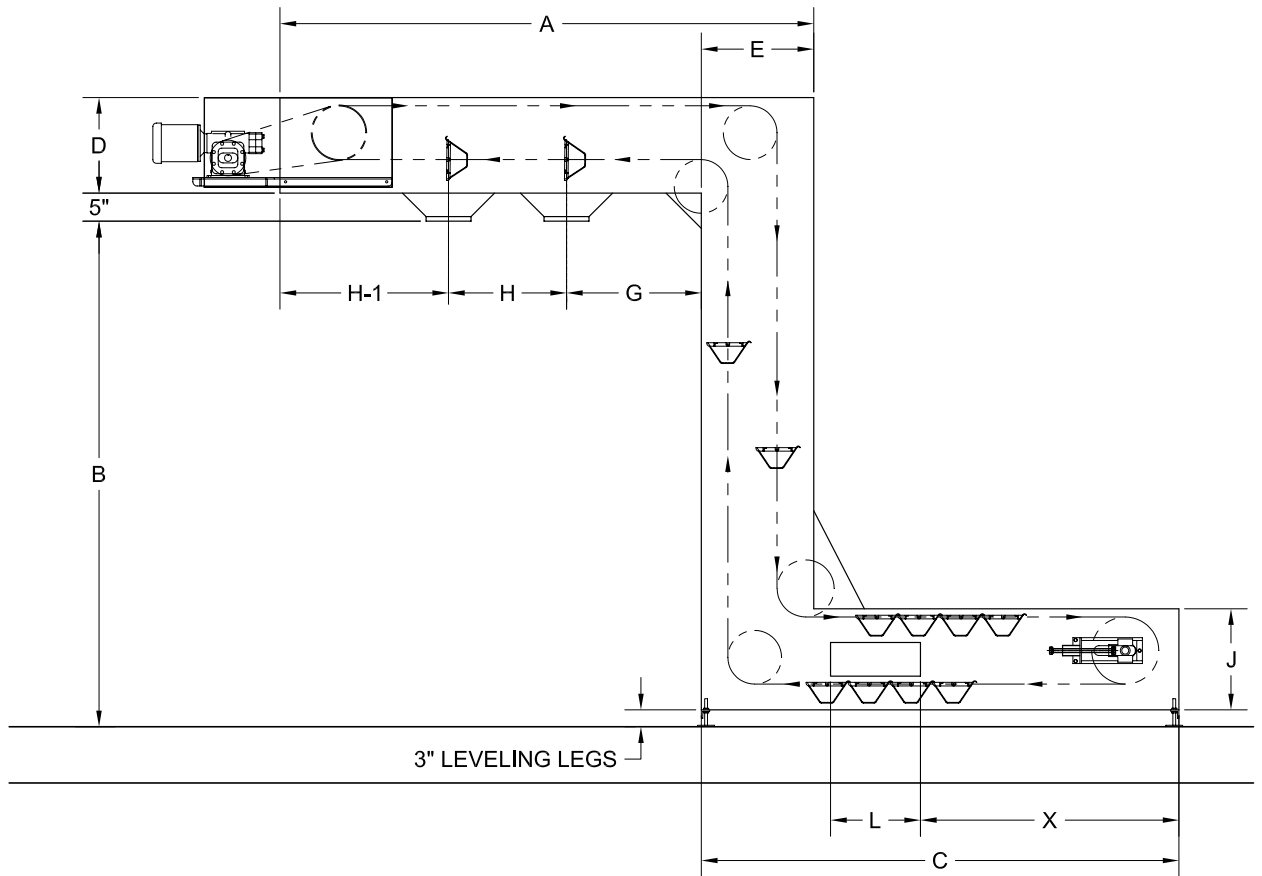
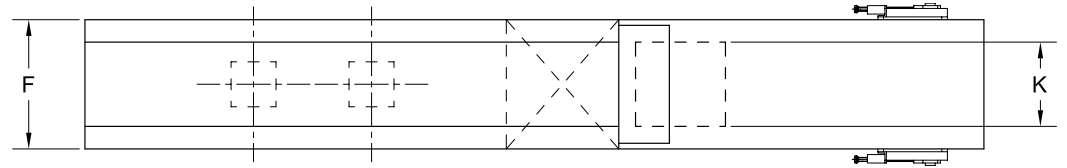

WHIZ-LIFTER MODEL CB - MULTIPLE DISCHARGE SANITARY CHANNEL FRAME CONSTRUCTION

BUCKET SIZE	A*	C*	D	E	F	G*	H*	H-1	J	K	L	X*
4" x 8"	67	60	12	13	15	18	15	21	12	8	12	28
6" x 10"	80	72	14	17	17	21	18	24	15	10	12	36
7-1/2" x 15"	95	85	17	20	23	24	21	30	18	15	16	46
9" x 20"	113	100	20	23	28	30	24	36	21	20	14	52
12" x 30"	152	124	26	30	39	36	36	50	26	30	23	66

*Minimum Dimensions



FRAZIER & SON

PO Box 2847
Conroe, Texas 77305

101 Longview Drive
Conroe, Texas 77301

800.365.5438
936.494.4040
Fax: 936.494.4045

BUCKET ELEVATORS
CONFIGURATION SHEET 7

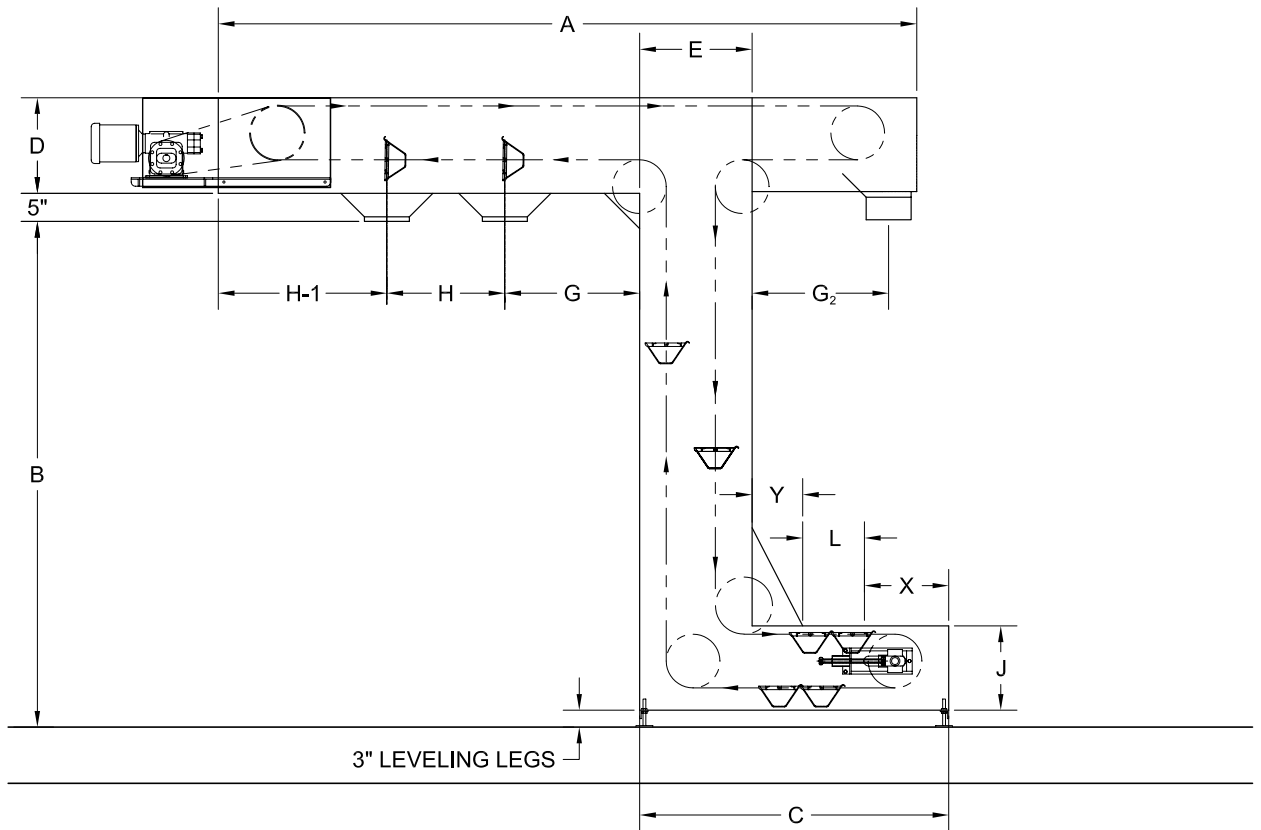
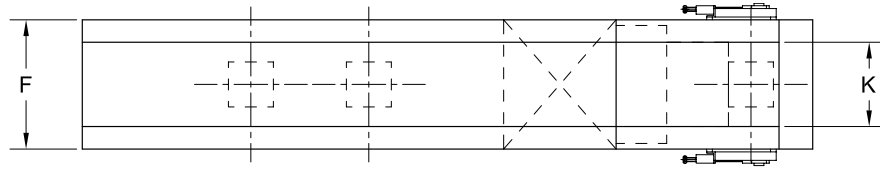

WHIZ-LIFTER
MODEL CBT-RE - MULTIPLE DISCHARGE with RETURN
SANITARY CHANNEL FRAME CONSTRUCTION

BUCKET SIZE	A*	C*	D	E	F	G*	G ₂ *	H*	H-1*	J	K	L	X	Y
4" x 8"	67	48	12	13	15	18	18	15	25	10	8	19	10	6
6" x 10"	80	52	14	17	17	21	21	18	30	12	10	16	12	7
7-1/2" x 15"	95	55	17	20	23	24	24	21	38	15	15	11	15	9
9" x 20"	113	72	20	23	28	30	30	24	45	18	20	19	19	11
12" x 30"	152	90	26	30	39	36	36	36	62	24	30	21	24	15

*Minimum Dimensions



FRAZIER & SON

PO Box 2847
Conroe, Texas 77305

101 Longview Drive
Conroe, Texas 77301

800.365.5438
936.494.4040
Fax: 936.494.4045

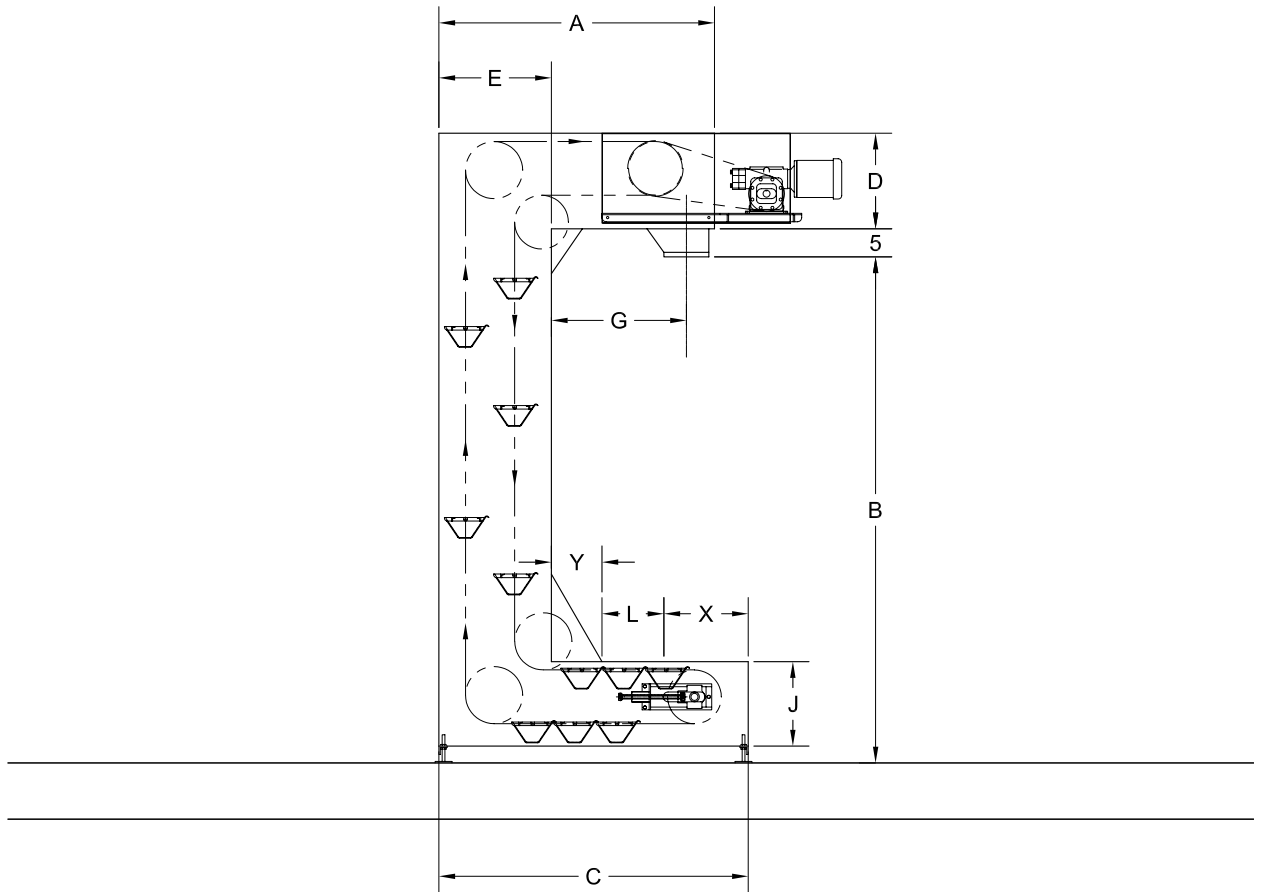
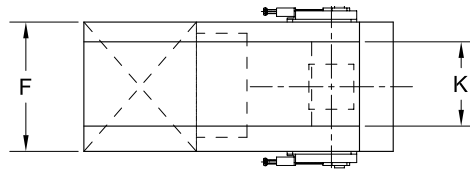

BUCKET ELEVATORS CONFIGURATION SHEET 8

WHIZ-LIFTER MODEL CU SANITARY CHANNEL FRAME CONSTRUCTION

BUCKET SIZE	A*	C*	D	E	F	G*	J	K	L	X	Y
4" x 8"	35	48	12	13	15	18	10	8	7	10	6
6" x 10"	42	52	14	17	17	21	12	10	6	12	7
7-1/2" x 15"	49	55	17	20	23	24	15	15	11	15	9
9" x 20"	60	72	20	23	28	30	18	20	19	19	11
12" x 30"	73	90	26	30	39	36	24	30	21	24	15

*Minimum Dimensions



FRAZIER & SON

PO Box 2847
Conroe, Texas 77305

101 Longview Drive
Conroe, Texas 77301

800.365.5438

936.494.4040

Fax: 936.494.4045

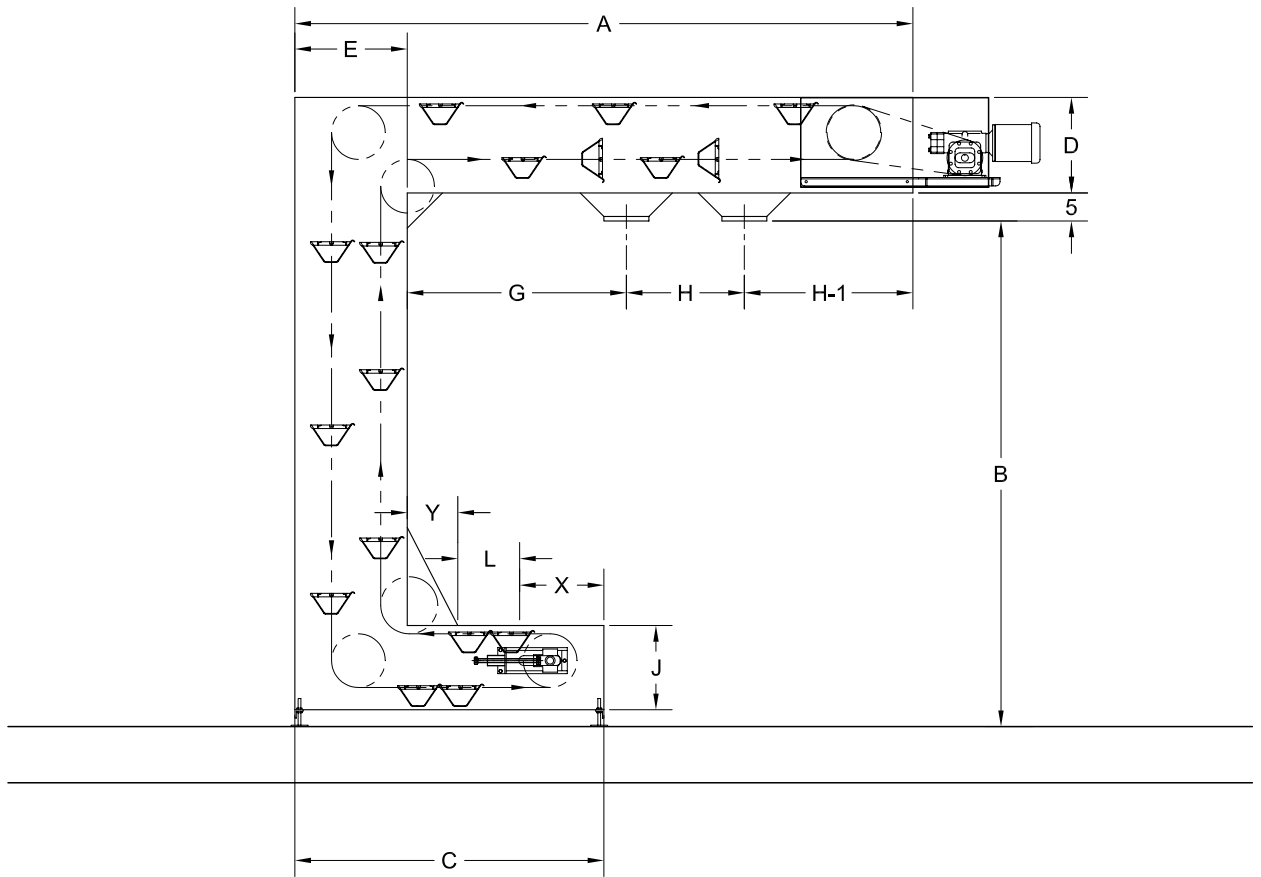
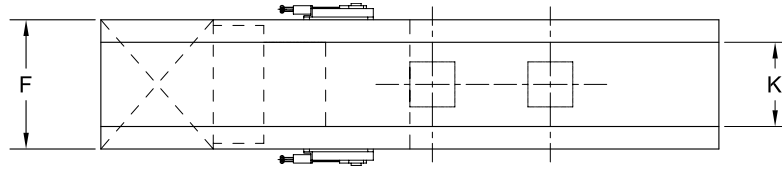

BUCKET ELEVATORS CONFIGURATION SHEET 9

WHIZ-LIFTER MODEL CBT-U MULTIPLE DISCHARGE SANITARY CHANNEL FRAME CONSTRUCTION

BUCKET SIZE	A*	C*	D	E	F	G*	H*	H-1	J	K	L	X	Y
4" x 8"	75	36	12	13	15	26	15	21	10	8	7	10	6
6" x 10"	92	42	14	17	17	33	18	24	12	10	6	12	7
7-1/2" x 15"	110	55	17	20	23	39	21	30	15	15	11	15	9
9" x 20"	131	72	20	23	28	48	24	36	18	20	19	19	11
12" x 30"	176	90	26	30	39	60	36	50	24	30	21	24	15

*Minimum Dimensions